



# WEBINAR AND DEMO: Enhanced IEC 61850 Sampled Values streaming with the RTDS Simulator's GTFPGA Unit



# AGENDA

- Hardware primer:  
GTNETx2 vs. GTFPGA Unit
- GTFPGA-SV-V3 capabilities
- RSCAD demonstration
- Q&A



# THE RTDS SIMULATOR AND IEC 61850



- The IEC 61850 standard defines communication protocols for substation IEDs and provide an overview of the communication/interaction architecture for substation automation systems
- RTDS Simulator development team actively participates in various industry events and working groups, including those focused on IEC 61850:
  - UCA IUG
  - IEC TC 57
- Industry direction and RTDS users drive development of new capabilities and features

# HIL INTERFACE WITH IEC 61850

## RTDS Simulator

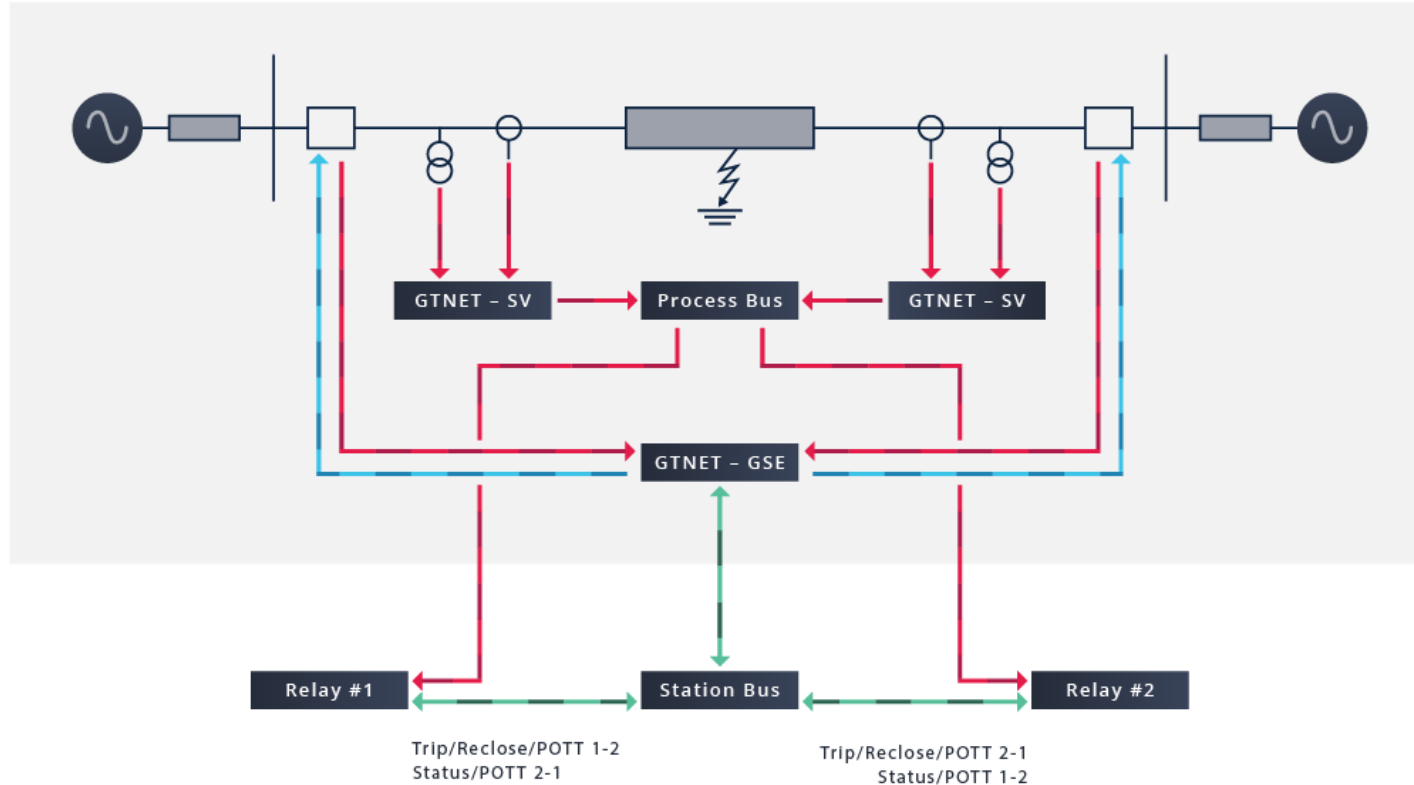

## Devices Under Test

# GTNETx2 Card for Network Communication

- Communication with external devices over Ethernet.
- Card has two “modules”, and can have two network protocols operating simultaneously.

## Available firmwares:

### IEC 61850

GOOSE Messaging  
IEC 61850-9-2LE, IEC 61869-9

### SCADA

DNP3 and IEC 60870-5-104

Large data playback

### PMU

IEEE C37.118

### MODBUS

TCP, RTU over TCP,  
ASCII over TCP

Generic TCP/UDP  
Sockets

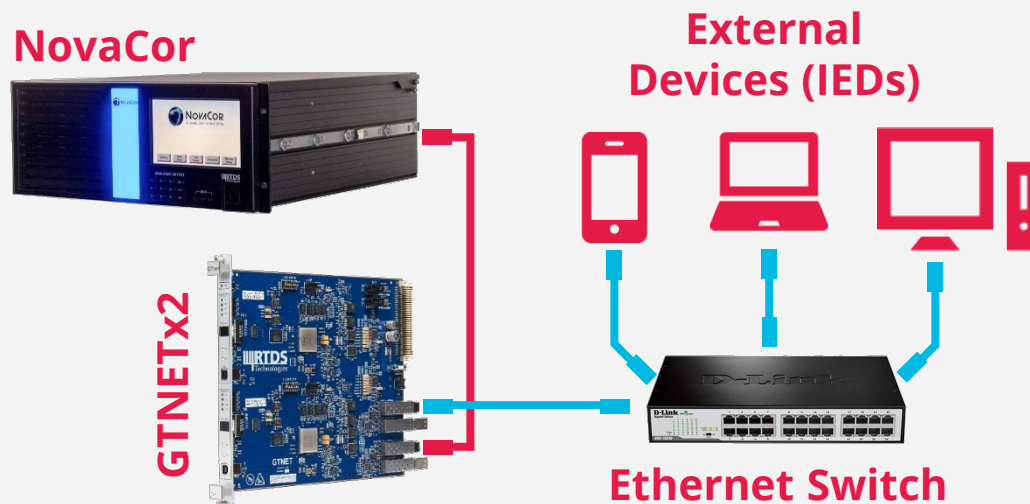

# GTFPGA UNIT

## Optional FPGA-based auxiliary hardware

- Connects to central NovaCor or PB5-based hardware via fibre cable
- Function defined by firmware – multiple firmwares available
  - MMC Valve and Control
  - Small timestep frequency dependent tline (12 conductors)
  - Generic Power Electronics Solver (GPES)
  - **Sampled Values (-9-2LE + IEC 61869-9)**

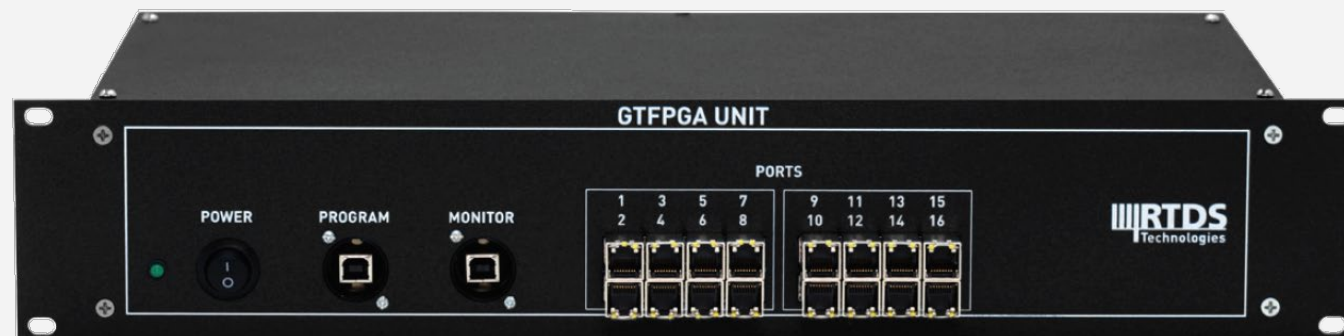

# GTFPGA UNIT

- 16 fibre/copper Ethernet ports
- Significantly more simultaneous published/subscribed SV streams than GTNET-SV
- Higher sampling rates than GTNET-SV (Substep operation possible)
- Now includes options for data/stream manipulation (not introduced for GTNET)
- Price is the same as GTNETx2 card

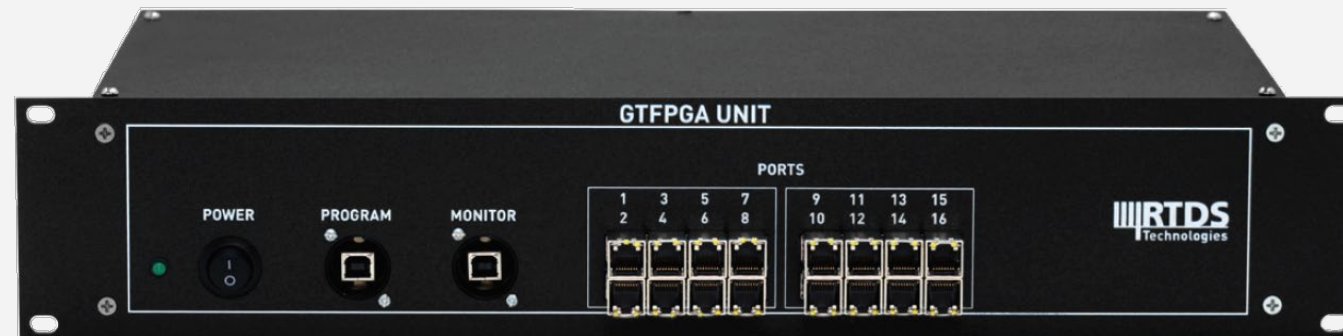



# GTSYNC Card

## for External Time Synchronization

- The GTSYNC card synchronizes the simulator to an external time reference (e.g. GNSS clock)
- Accepts external time reference inputs as,
  - 1 PPS (in/out via BNC or ST fiber)
  - IEEE 1588 PTP (in via RJ45 or ST fiber)
  - IRIG-B (in via BNC)
- If an external time reference is not available, an internal 1PPS source can provide a time reference
- Necessary for PMU testing
- **Advantageous for SV output**

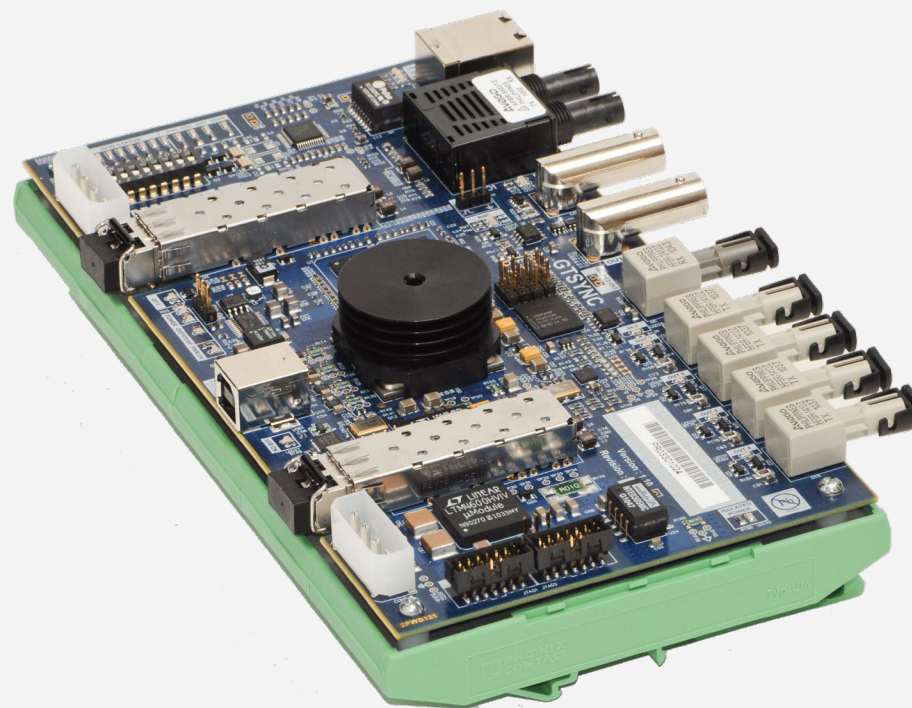





Thank you!



RTDS.COM



# IEC 61850 Sampled Values Communication using RTDS Simulator and GTFPGA



# IEC 61850 SV

- Protection & control systems increasingly rely on critical measurements delivered through IEC 61850/IEC 61869 Sampled Value (SV)
- SV is one of the most commonly used protection & automation protocol to interface the simulator with external IEDs
- Non-genuine and non-ideal SV streams → misoperation, serious damage, cascading failures
- Need to identify the weakness and vulnerability of SV-based protection systems

# GTFPGA-SV Hardware

- 16 fiber/copper Ethernet ports
- 100 Mbit/s or 1Gbit/s
- Publish (output) and subscribe (input) up to 16 independent SV streams **simultaneously**
- GTFPGA unit connects to the simulator by an optical fibre

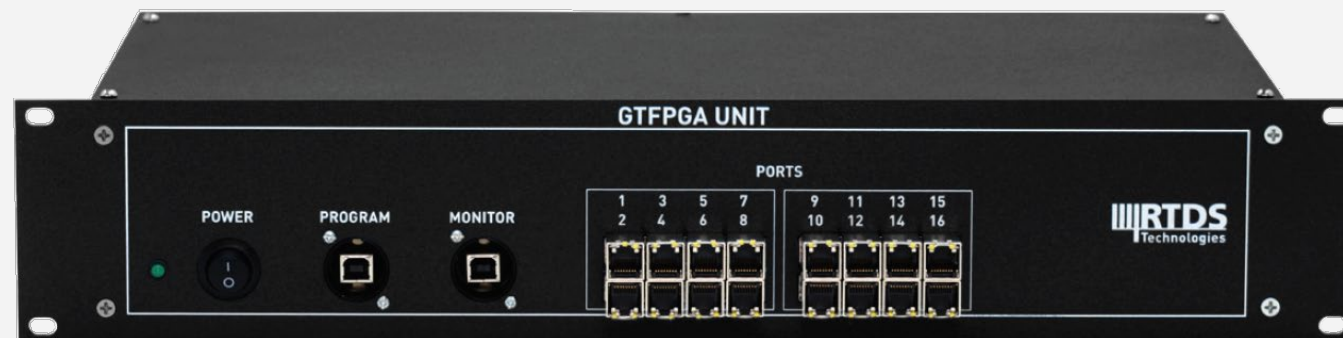

# Typical Connection

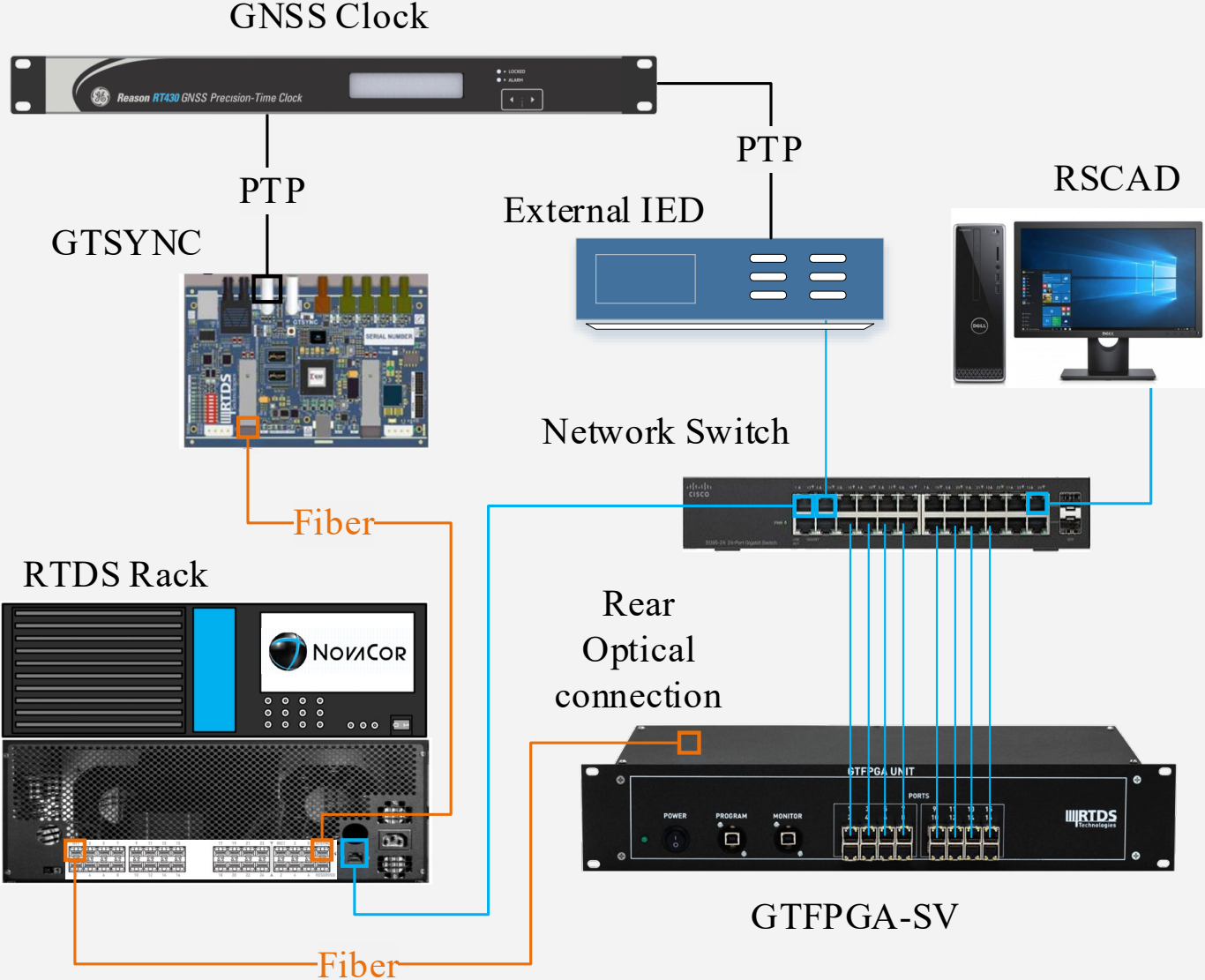

# Sampling Rates

**Table 902 – Standard sample rates**

Digital output sample rates Hz	Number of ASDUs per frame	Digital output publishing rate frames/s	Remarks
4 000	1	4 000	For use on 50 Hz systems backward compatible with 9-2LE guideline.
4 800	1	4 800	For use on 60 Hz systems backward compatible with 9-2LE guideline, or 50 Hz systems backward compatible with 96 samples per nominal system frequency cycle.
4 800	2	2 400	Preferred rate for general measuring and protective applications, regardless of the power system frequency.
5 760	1	5 760	For applications on 60 Hz systems backward compatible with 96 samples per nominal system frequency cycle.
12 800	8	1 600	Deprecated, only for use on 50 Hz systems.
14 400	6	2 400	Preferred rate for quality metering applications, regardless of the power system frequency including instrument transformers for time critical low bandwidth d.c. control applications.
15 360	8	1 920	Deprecated, only for use on 60 Hz systems.
96 000	1	96 000	Preferred rate for instrument transformers for high bandwidth d.c. control applications.



# Capabilities

## Sampling Rates and Number of Channels

Mode	Max. Number of SV Streams	Sampling Rate	Max. Number of Channels per Stream
Mainstep	16 Outputs and 16 Inputs	80 s/c, 96 s/c, 4800 Hz	24
		256 s/c, 14400 Hz	9
Substep	2 (Output only)	96 kHz	24
	1 (Output only)	250 kHz	48

# 250 kHz Sampling Rate

High bandwidth HVDC protection and control applications

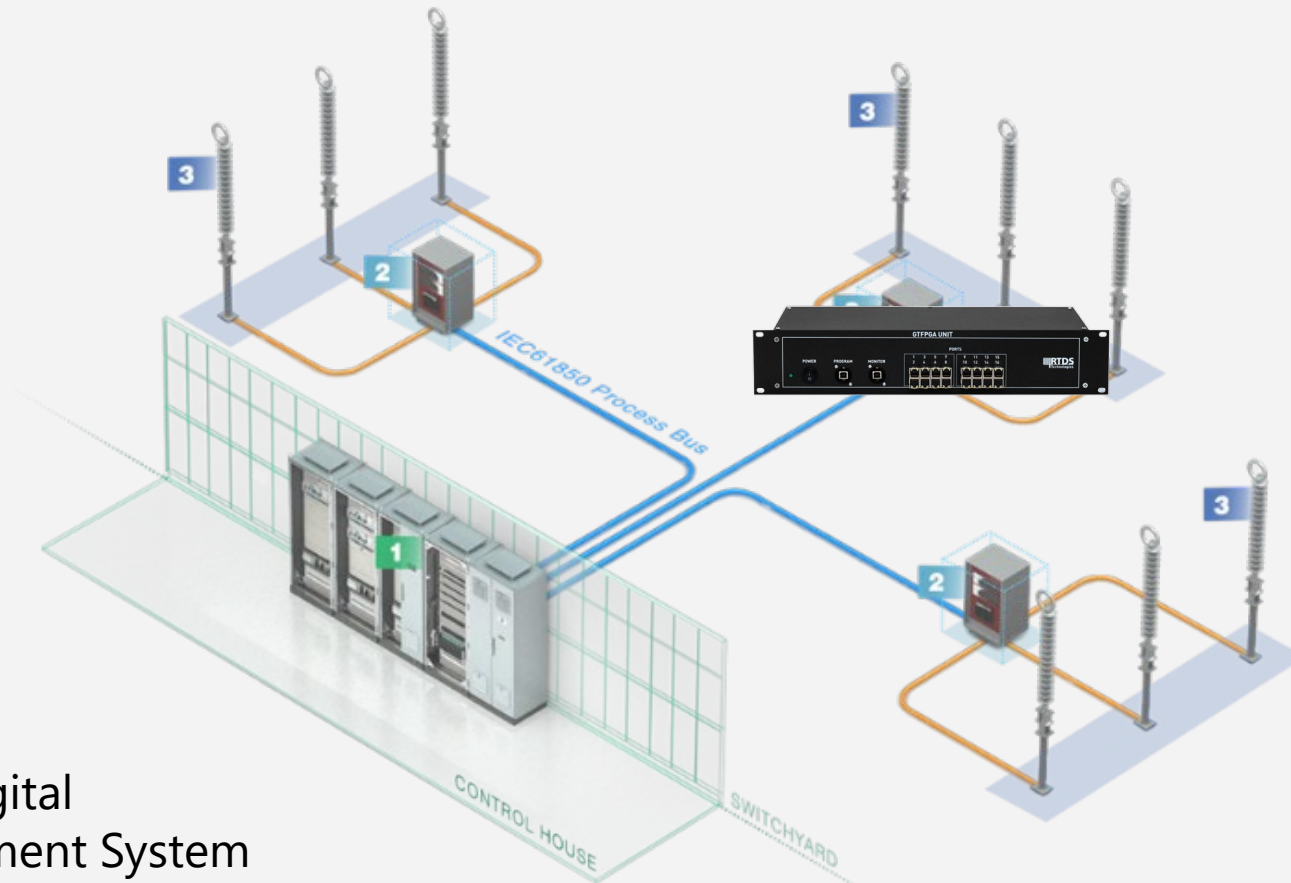

HVDC Digital  
Measurement System

# Subscriber

- SCL file parsing
- Filtering
  - APPID
  - Simulation Flag
- Monitoring
  - Packet interval (jitter stats)
  - Detailed subscription status (SV stream lost, CRC error, etc.)

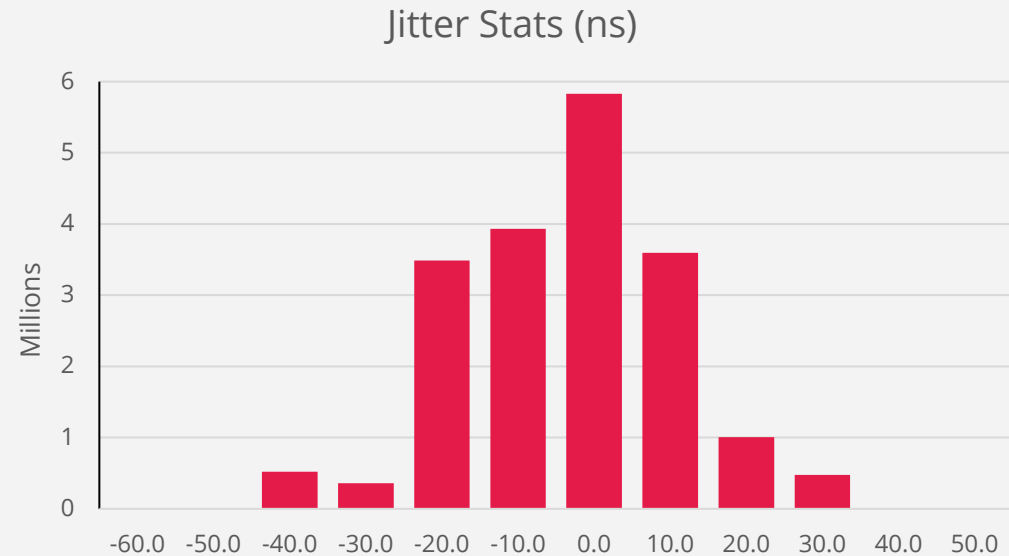

# Subscriber

## Raw vs Interpolated

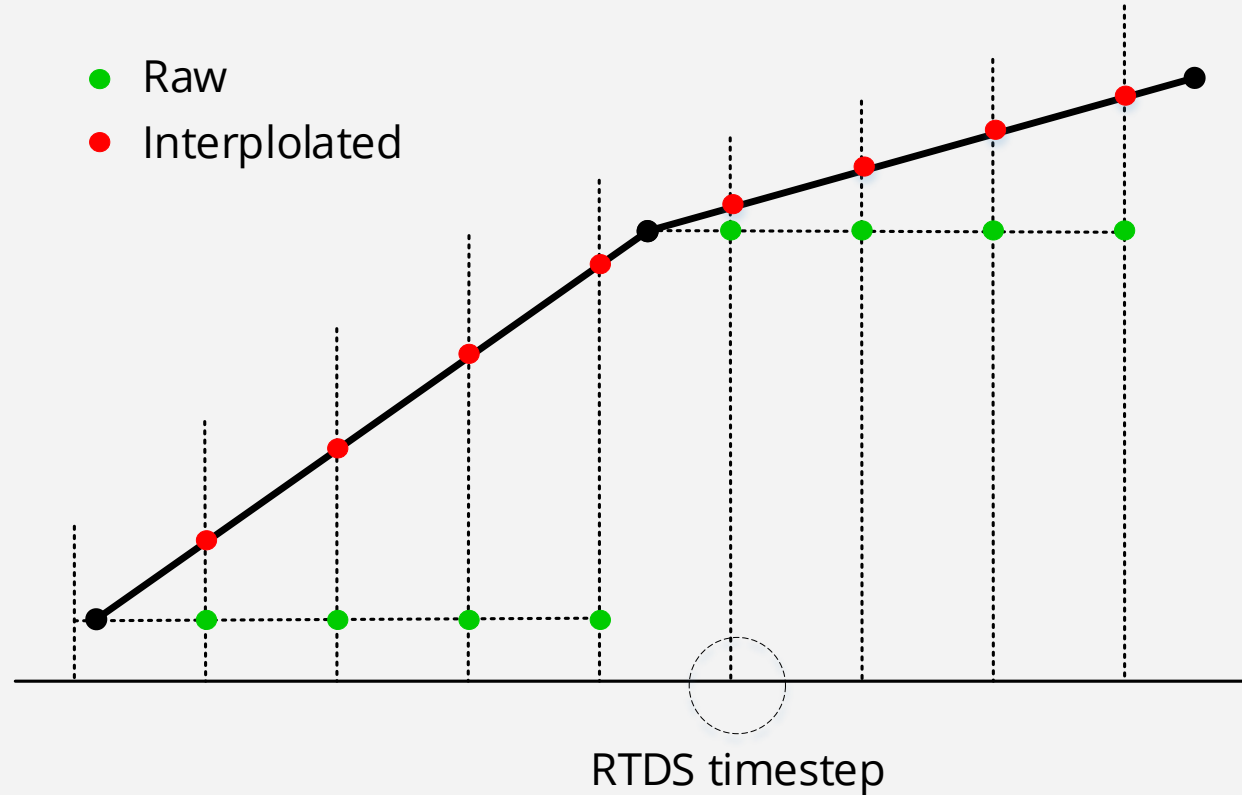

# Subscriber

## Raw

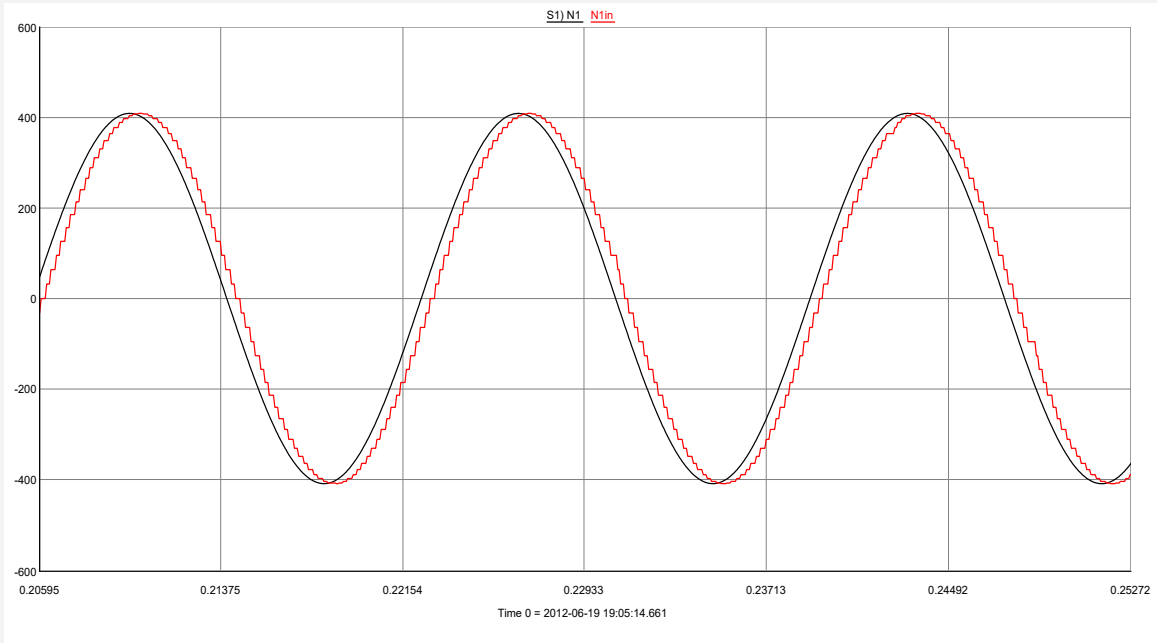

## Interpolated

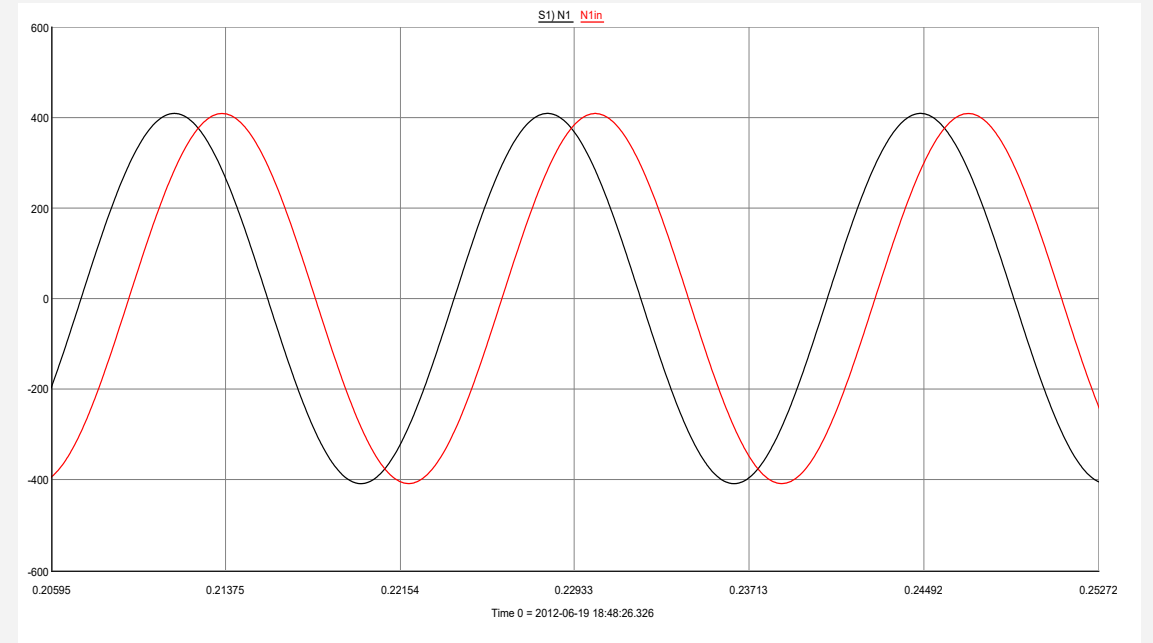

# SV Publisher Manipulation

## Data Manipulation

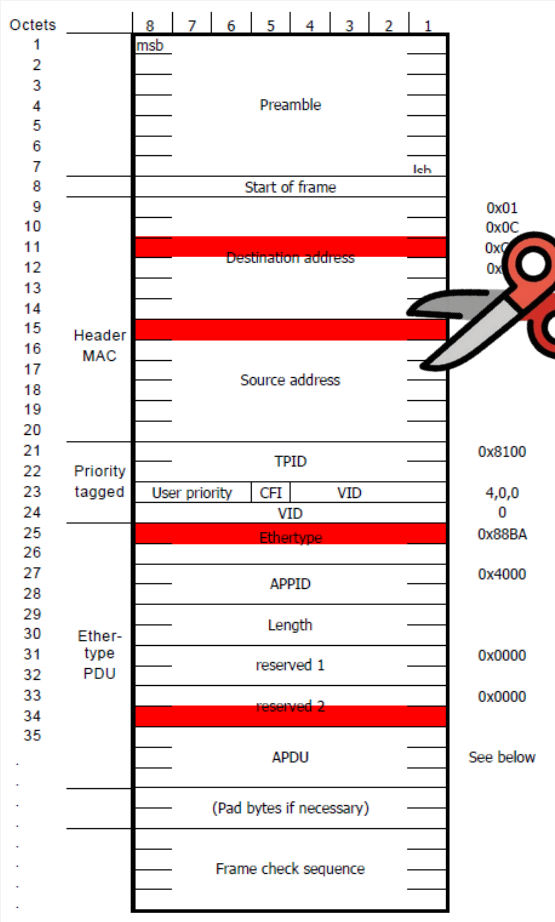

## Stream Manipulation

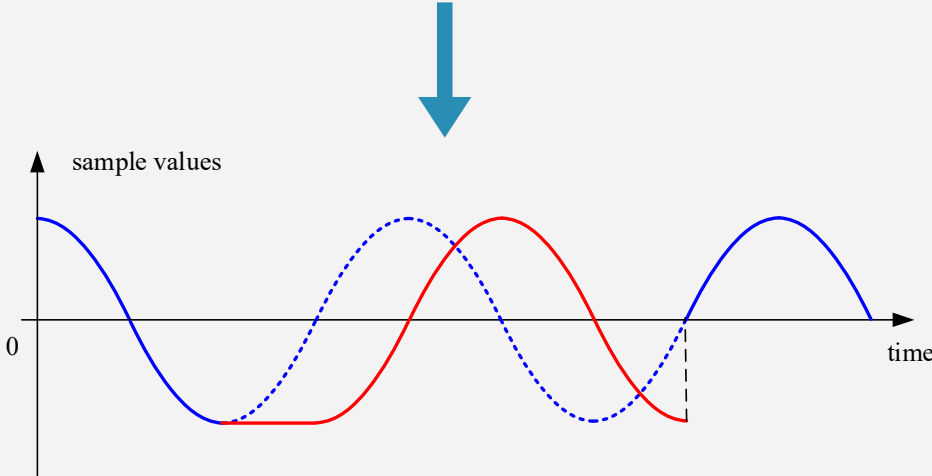



# Data Manipulation

- |                        |                             |
|------------------------|-----------------------------|
| 1) VLAN Priority       | 7) Number of ASDU           |
| 2) VLAN ID             | 8) Configuration revision   |
| 3) Application ID      | 9) Sample count             |
| 4) Length of SV packet | 10) Destination MAC address |
| 5) Reserved 1          | 11) Source MAC address      |
| 6) Reserved 2          | 12) Stream identification   |

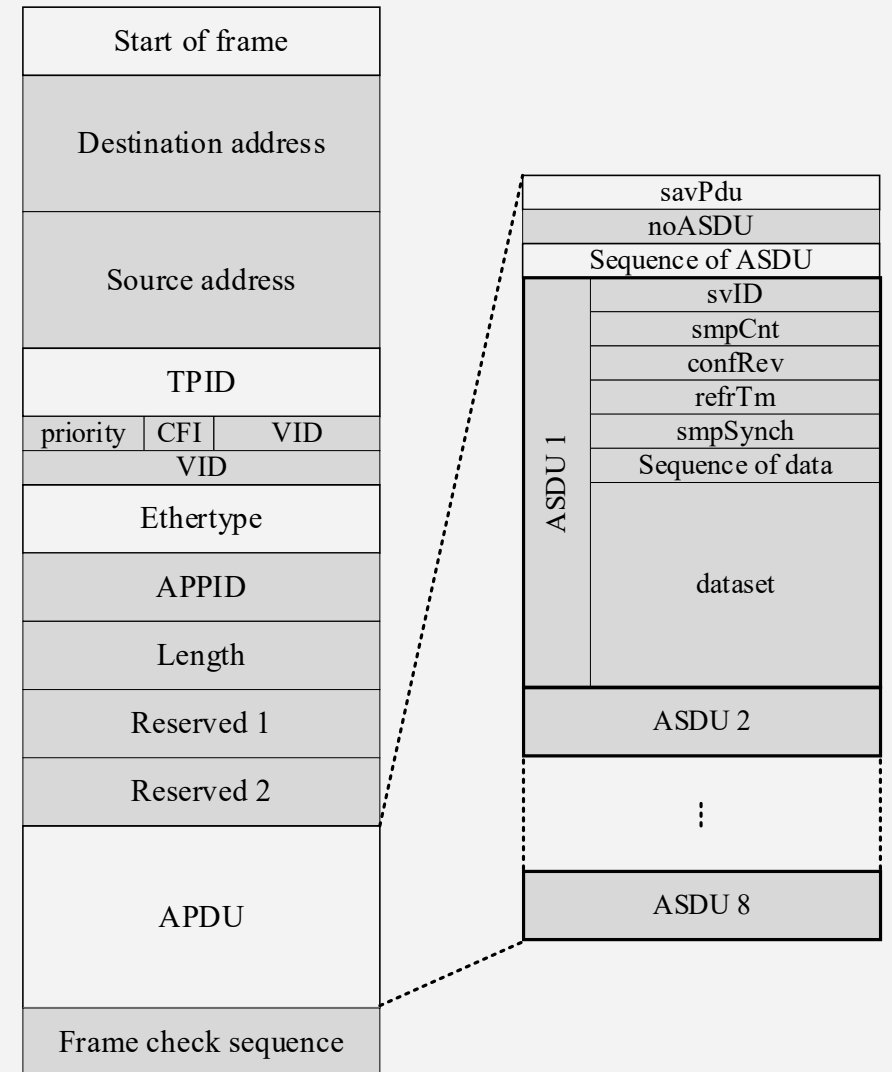

# Stream Manipulation

- 1) Stop/resume
- 2) Duplicate
- 3) Swap
- 4) Delay
- 5) Jitter

# 1) Stop/Resume

stop/resume publishing during runtime to simulate the loss of packets on the network

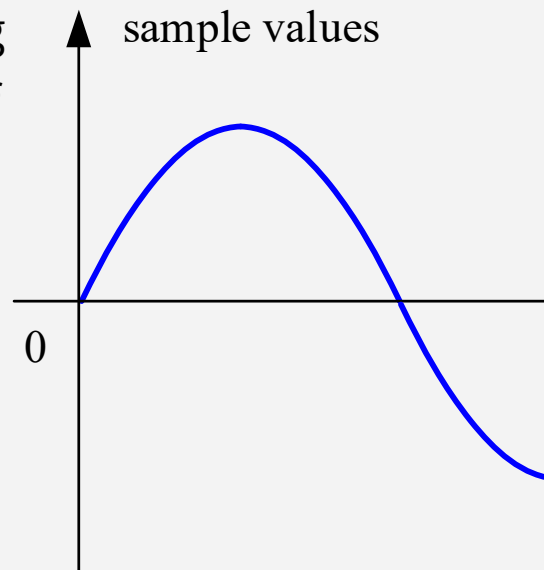

## 2) Duplicate

duplicate packets to simulate  
a problematic network  
topology

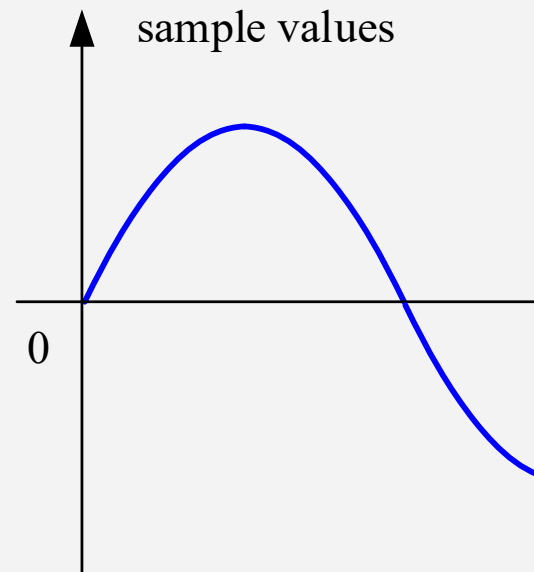

# 3) Swap

swap the order of two packets to simulate non-sequential arriving of packets, due to problematic network routing

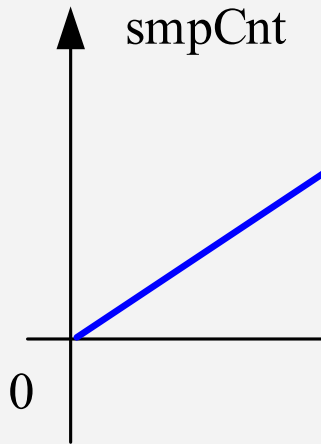

# 4) Delay

delay publishing to  
simulate unwanted  
latency on the network

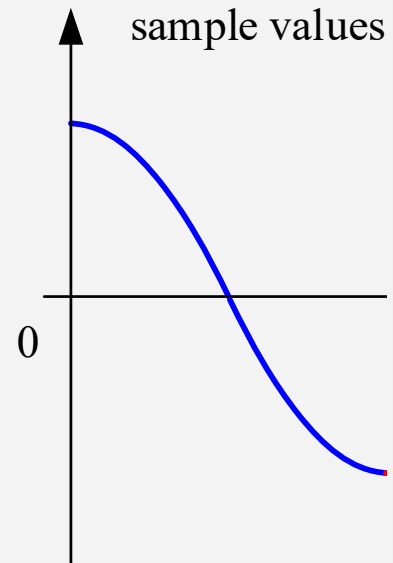



# 5) Jitter

- add positive/negative jitter to simulate the variance of latency
- Resolution: 10 ns

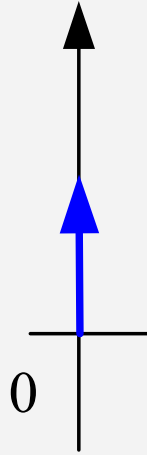

# Data Manipulation

Field name	IED response
Destination MAC	Subscription stop
Source MAC	Does not affect
VLAN priority	Does not affect
VLANID	Subscription stop
APPID	Subscription stop
Length	Subscription stop
Reserved 1	Does not affect
Reserved 2	Does not affect
noASDU	Subscription stop
svID	Does not affect
smpCnt	Affected for operation
confRev	Subscription stop
smpSynch	Does not affect

# Data Manipulation: smpCnt

- Manipulate 3 smpCnt
- Half-cycle abnormal measurements
- Corrupt IED buffer
- During resampling, generate incorrect values

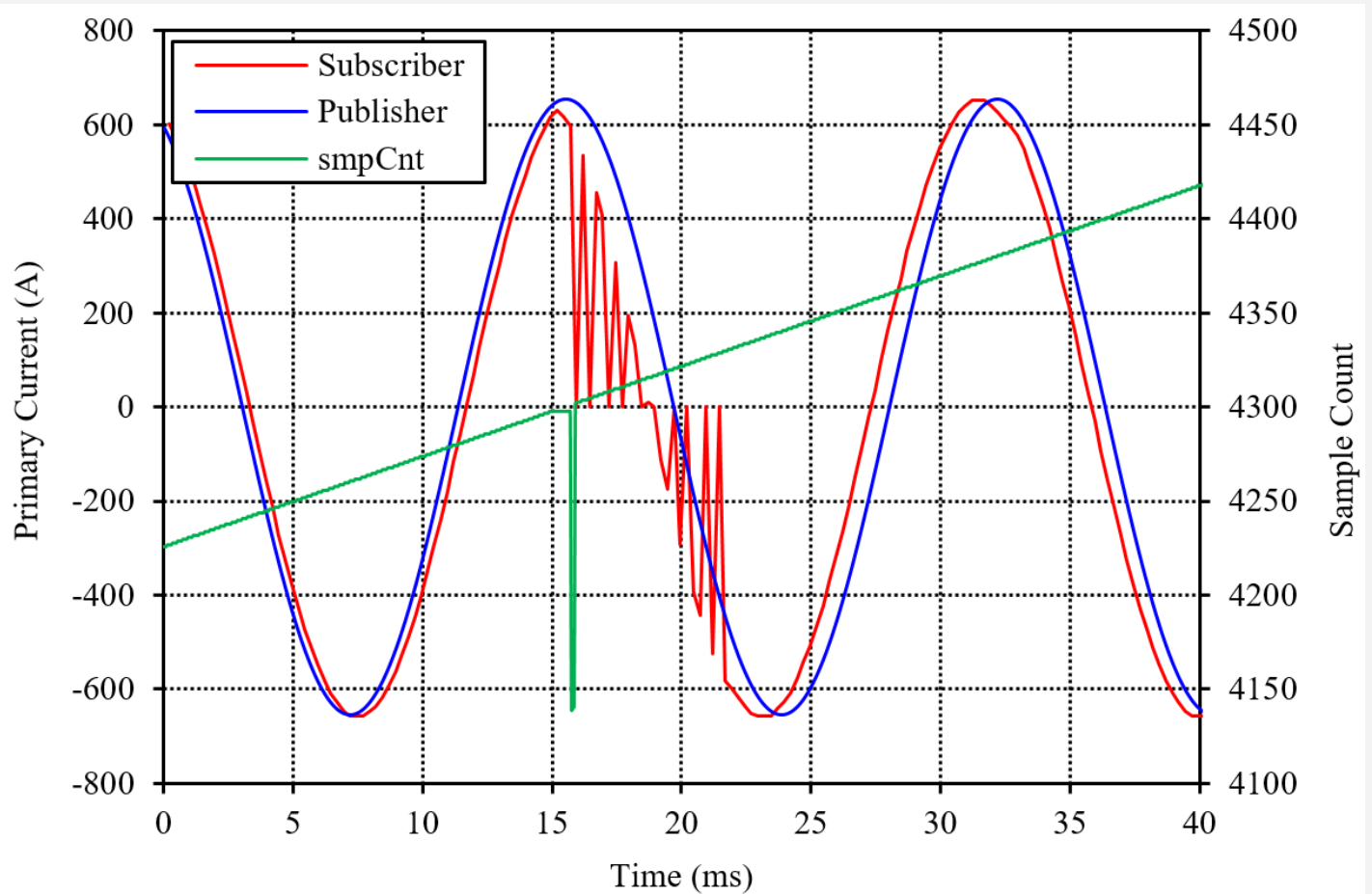

# Stream Manipulation: latency & jitter

- Latency
  - Delayed 2.5 ms
  - IED operated normally
  - IED's data buffer reduce the impact of delay
- Jitter
  - Gaussian distribution jitter
  - Standard deviation 2.5 ms
  - IED operated normally
  - IED's data buffer reduce the impact of jitter

# Summary

- GTFPGA unit combined with RTDS simulator allows for efficient/accurate testing of many SV-compliant devices
- Up to 16 SV streams can be published/subscribed simultaneously and independently
- Suitable for ultra high bandwidth applications such as HVDC protection and control applications
- SV manipulation allow users to identify and address vulnerabilities in SV-based protection before the deployment on the grid



# RSCAD Demonstration



[RTDS.COM](http://RTDS.COM)